

# PC41 & PC42 SERIES DESKTOP PRINTER

Configuration Guide



**PC41E-D**  
**DIRECT**  
**THERMAL**

**PC42E-D**  
**DIRECT**  
**THERMAL**

**PC42E-T**  
**THERMAL**  
**TRANSFER**

THE  
FUTURE  
IS  
WHAT  
WE  
MAKE IT

**Honeywell**

# TABLE OF CONTENTS

- 1 Table Of Contents**
- 2 PC41 & PC42 Series**  
Compare the models
- 3 PC41E-D Feature Overview**  
Tear Off - 1-Button/ LED - Black - Direct Thermal
- 4 PC41E-D Configuration Map**  
Desktop Printer
- 5 PC42E-D Printing Options**
- 6 PC42E-D Media**  
Specifications
- 8 PC42E-D Feature Overview**  
Tear Off - Multi-Button/ LED - Black - Direct Thermal  
Tear Off - Multi-Button/ LED - Black - Media Low Sensor - Direct Thermal  
Tear Off - Multi-Button/ LED - White - Direct Thermal
- 11 PC42E-D Configuration Map**  
Desktop Printer
- 12 PC42E-T Printing Options**
- 13 PC42E-T Media**  
Specifications
- 14 PC42E-T Media**  
Specifications
- 15 PC42E-T Feature Overview**  
Tear Off - 1-Button/ LED - Black - Thermal Transfer  
Tear Off - 1-Button/ LED - White - Thermal Transfer
- 17 PC42E-T Configuration Map**  
Desktop Printer
- 18 Honeywell EDGE services**  
Gold Repair Services - 3 Year  
Platinum Repair Services - 3 Year

- 19 Honeywell EDGE services**  
Gold Repair Services - 5 Year  
Platinum Repair Services - 5 Year  
PC41E-D / PC42E-D / PC42E-T - Repair Services Coverage
- 21 Accessories**  
PC42E-D / PC42E-T - Wi-Fi and Bluetooth Card  
PC42E-D Cutter  
PC42E-T Cutter  
PC42E-D Peel Off (Self Strip)  
PC42E-T Peel Off (Self Strip)  
Consumables and Cables
- 25 Miscellaneous**  
Power Supply  
AC Cords
- 26 Appendix**  
PC41E-D / PC42E-D / PC42E-T Accessories  
Connectivity - Compare PC41E-D / PC42E-D / PC42E-T



# PC41 & PC42 SERIES

## Compare the models



### PC41E-D

#### 1 Button / 1 LED

- Direct Thermal (DT)
- 203 dpi - 4-8 ips
- 300 dpi - 4-6 ips
- USB Only
- Does NOT support Serial, Ethernet or Wi-Fi



### PC42E-D

#### Multiple Button / Multiple LED

- Direct Thermal (DT)
- 203 dpi - 4-8 ips
- 300 dpi - 4-6 ips
- USB, Serial and Ethernet
- Label Taken Sensor + Peel Off
- Cutter

#### Supported I/O Cards

- Wi-Fi / Bluetooth Interface  
European Union (EU) (3012-6759-001)  
North America (3012-6760-001)  
Rest Of World (ROW) (3012-6761-001)



### PC42E-T

#### Multiple Button / Multiple LED

- Thermal Transfer (TT)
- 203 DPI - 2-6 ips
- 300 DPI - 2-5 ips
- USB, Serial and Ethernet
- Label Taken Sensor + Peel Off
- Cutter

#### Supported I/O Cards

- Wi-Fi / Bluetooth Interface  
European Union (EU) (3012-6759-001)  
North America (3012-6760-001)  
Rest Of World (ROW) (3012-6761-001)

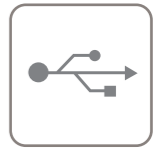

USB



Direct Thermal (DT) Printing

# PC41E-D FEATURE OVERVIEW

**Tear Off - 1-Button/ LED - Black - Direct Thermal**



### PC41E-D - 1-Button/ LED - Direct Thermal - 203 dpi

**PC41EDB010200** PC41E-D, 4-inch, 1-Button/ LED, USB, Direct Thermal (DT) 203 dpi, includes Power Supply, No Power Cord

### PC41E-D - 1-Button/ LED - Direct Thermal - 300 dpi

**PC41EDB010300** PC41E-D, 4-inch, 1-Button/ LED, USB, Direct Thermal (DT) 300 dpi, includes Power Supply, No Power Cord

Included in the box:

- PC41E-D
- PC41E-D Regulatory Sheet (PC41E-ML-RS-01)
- Power Supply (203-186-002)
- USB Cable (321-576-004)



- No Power Cord

Note: Not all printer combinations are available in every region. Check your local Price Book to see which part numbers are available for sale.

### Honeywell Repair Services

**SVCPC41ED-SG3N** PC41E-D, Edge Service, Gold Maintenance Contract, 3 Year, New Contract

**ADD SVCPRINTHEAD-PC3** AddOn, Edge Service, Printhead Refresh Service, 203 or 300 dpi, 3-Year Contract

**ADD SVCACC-PRN3** AddOn, Edge Service, Accessory Service, Printer, 3 Year

# PC41E-D CONFIGURATION MAP

## Desktop Printer

VERSION	HOUSING	CUSTOMIZATION	CONNECTIVITY	MEDIA HANDLING	PRINT OPTION	POWER CORD	DESCRIPTION	NOTES
<b>PC41E</b>								
D							Direct Thermal (DT)	
	B						Black	
		0					Default	
			1				USB	1x USB A Port (USB 2.0 Host), 1x USB B Port (USB 2.0 Device)
				0			None	
					20		203 dpi	Available as Kit - Part# 3012-6757-002 TPH 203DPI,PC41E-D/PC42E-D SERIES
					30		300 dpi	Available as Kit - Part# 3012-6758-002 TPH 300DPI,PC41E-D/PC42E-D SERIES
						0	None	AC Power Cord C13 Type Connector
						1	US Power Cord	AC Power Cord C13 Type Connector
						5	India Power Cord	AC Power Cord C13 Type Connector
						9	China Power Cord	AC Power Cord C13 Type Connector



# PC42E-D PRINTING OPTIONS



## Tear Off

Most commonly used, print any number of labels and simply tear the labels off from the printer at the end of the print job. This method of printing is available on any PC41E-D or PC42E-D configuration.



## Peel & Present (Self-Strip)

Self-Strip prints and presents only one label at a time already peeled from the backing strip/ liner, the next label will only be printed once the original label is removed from the media path. 3012-6755-002 PC42E-D Self-Strip + LTS Kit



## Cutter

A cutter can be added to any configuration of PC42E-D, simply cutting between labels, or at intervals on continuous media. This method of printing is available on any PC42E-D configuration. 3012-6756-002 PC42E-D Cutter

ID = Inside Diameter  
OD = Outside Diameter

# PC42E-D MEDIA

## Specifications



ID = Inside Diameter  
OD = Outside Diameter

# PC42E-D MEDIA

## Specifications



Media Hanger + Label Roll Core 38 mm (1.5 in) ID

Shown with Label Roll 127 mm (5 in) OD

Typical length of material with typical thickness of labels ~ 72 m

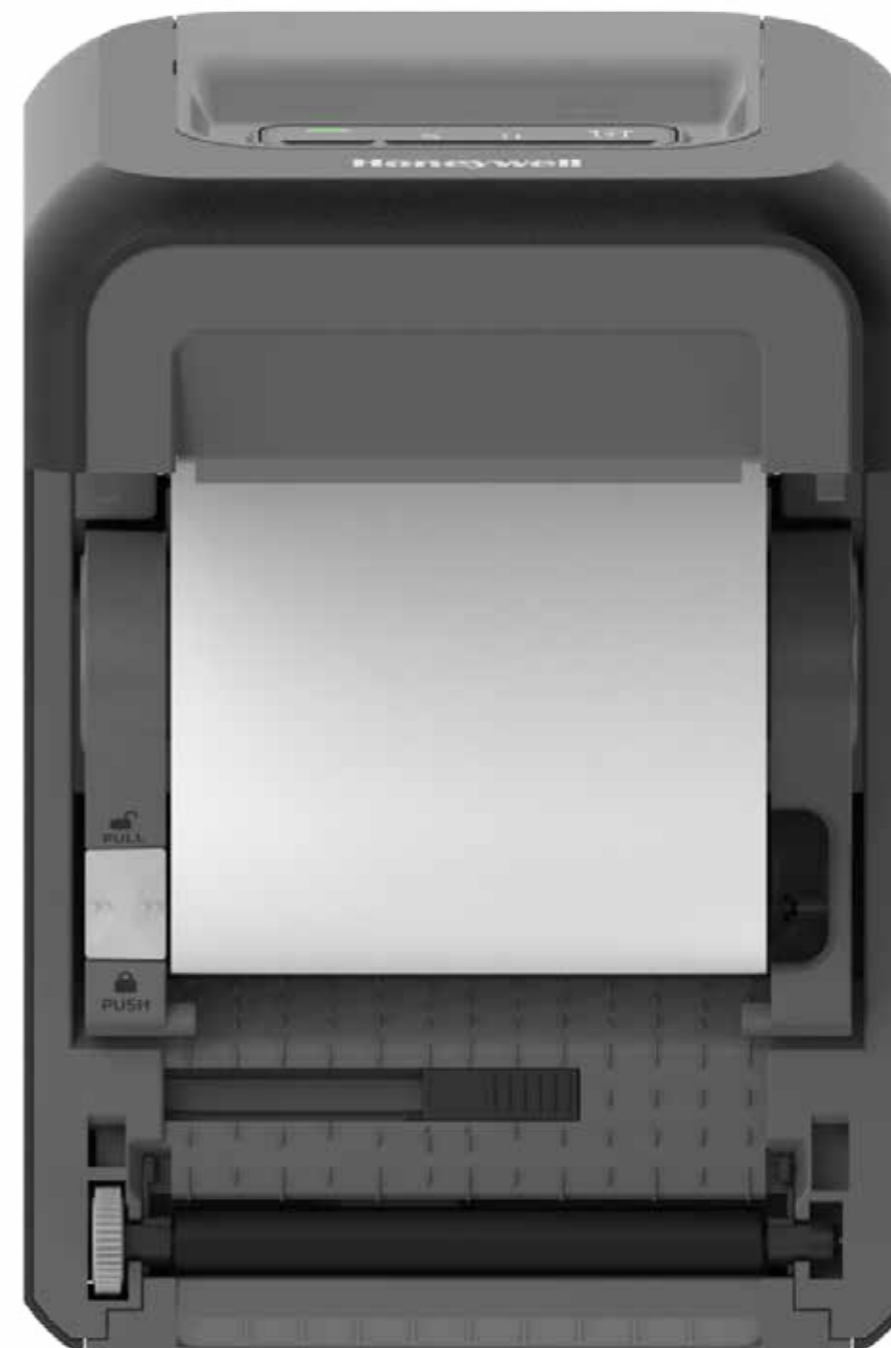

Adjustable Media Sensor

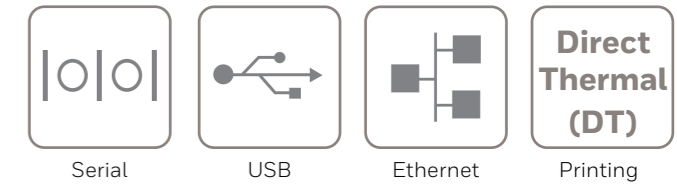

# PC42E-D FEATURE OVERVIEW

**Tear Off - Multi-Button/ LED - Black - Direct Thermal**



**PC42E-D - Multi-Button/ LED - Direct Thermal - 203 dpi**

**PC42EDB020200**

PC42E-D, 4-inch, Multi-Button/ LED, 256MB RAM/ 256MB Flash, Black, Ethernet + USB + Serial, No Option, Direct Thermal (DT) 203 dpi, No Power Cord

**PC42E-D - Multi-Button/ LED - Direct Thermal - 300 dpi**

**PC42EDB020300**

PC42E-D, 4-inch, Multi-Button/ LED, 256MB RAM/ 256MB Flash, Black, Ethernet + USB + Serial, No Option, Direct Thermal (DT) 300 dpi, No Power Cord

Included in the box:

- PC42E-D
- PC42E-D Regulatory Sheet (PC42E-ML-RS-01)
- Power Supply (203-186-002)
- USB Cable (321-576-004)



- No Power Cord

**Honeywell Repair Services**

SVCPC42ED-SG3N

PC42E-D, Edge Service, Gold Maintenance Contract, 3 Year, New Contract

**ADD** SVCPRINTHEAD-PC3

AddOn, Edge Service, Printhead Refresh Service, 203 or 300 dpi, 3-Year Contract

**ADD** SVCACC-PRN3

AddOn, Edge Service, Accessory Service, Printer, 3 Year

Note: Not all printer combinations are available in every region. Check your local Price Book to see which part numbers are available for sale.

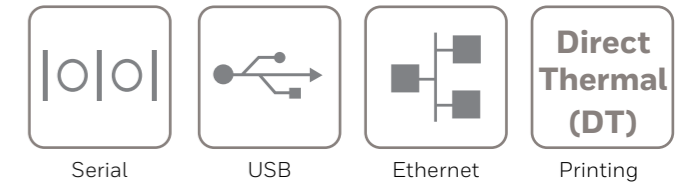

# PC42E-D FEATURE OVERVIEW

**Tear Off - Multi-Button/ LED - Black - Media Low Sensor - Direct Thermal**



**PC42E-D - Multi-Button/ LED - Direct Thermal - 203 dpi**

**PC42EDB021200**

PC42E-D, 4-inch, Multi-Button/ LED, 256MB RAM/ 256MB Flash, Black, Ethernet + USB + Serial, Media Low Sensor, Direct Thermal (DT) 203 dpi, No Power Cord

Included in the box:

- PC42E-D
- PC42E-D Regulatory Sheet (PC42E-ML-RS-01)
- Power Supply (203-186-002)
- USB Cable (321-576-004)



- No Power Cord

### Honeywell Repair Services

SVCPC42ED-SG3N

PC42E-D, Edge Service, Gold Maintenance Contract, 3 Year, New Contract

**ADD** SVCPRINTHEAD-PC3

AddOn, Edge Service, Printhead Refresh Service, 203 or 300 dpi, 3-Year Contract

**ADD** SVCACC-PRN3

AddOn, Edge Service, Accessory Service, Printer, 3 Year

Note: Not all printer combinations are available in every region. Check your local Price Book to see which part numbers are available for sale.

# PC42E-D FEATURE OVERVIEW

**Tear Off - Multi-Button/ LED - White - Direct Thermal**

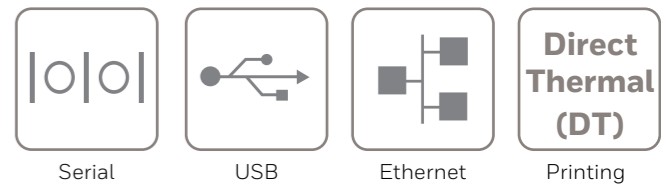

**PC42E-D - Multi-Button/ LED - Direct Thermal - 203 dpi**

**PC42EDW020200**

PC42E-D, 4-inch, Multi-Button/ LED, 256MB RAM/ 256MB Flash, White, Ethernet + USB + Serial, No Option, Direct Thermal (DT) 203 dpi, No Power Cord

Included in the box:

- PC42E-D
- PC42E-D Regulatory Sheet (PC42E-ML-RS-01)
- Power Supply (203-186-002)
- USB Cable (321-576-004)



- No Power Cord

### Honeywell Repair Services

SVCPC42ED-SG3N

PC42E-D, Edge Service, Gold Maintenance Contract, 3 Year, New Contract

**ADD** SVCPRINTHEAD-PC3

AddOn, Edge Service, Printhead Refresh Service, 203 or 300 dpi, 3-Year Contract

**ADD** SVCACC-PRN3

AddOn, Edge Service, Accessory Service, Printer, 3 Year

Note: Not all printer combinations are available in every region. Check your local Price Book to see which part numbers are available for sale.

# PC42E-D CONFIGURATION MAP

## Desktop Printer

VERSION	HOUSING	CUSTOMIZATION	CONNECTIVITY	MEDIA HANDLING	PRINT OPTION	POWER CORD	DESCRIPTION	NOTES
<b>PC42E</b>								
D							Direct Thermal (DT)	
	B						Black	
	W						White	
		0					Default	
			1				USB	USB Only
			2				USB + Ethernet + Serial	1 x USB A Port (USB 2.0 Host), 1 x USB B Port (USB 2.0 Device), 1 x Ethernet, 1 x DB9F Serial
				0			None	
				1			Media Low Sensor	
					20		203 dpi	Available as Kit - Part# 3012-6757-002 TPH 203DPI,PC41E-D/PC42E-D SERIES
					30		300 dpi	Available as Kit - Part# 3012-6758-002 TPH 300DPI,PC41E-D/PC42E-D SERIES
						0	None	AC Power Cord C13 Type Connector
						1	US Power Cord	AC Power Cord C13 Type Connector
						5	India Power Cord	AC Power Cord C13 Type Connector
						9	China Power Cord	AC Power Cord C13 Type Connector



# PC42E-T PRINTING OPTIONS



## Tear Off

Most commonly used, print any number of labels and simply tear the labels off from the printer at the end of the print job. This method of printing is available on any PC42E-T configuration.

## Peel & Present (Self-Strip)

Self-Strip prints and presents only one label at a time already peeled from the backing strip/ liner, the next label will only be printed once the original label is removed from the media path. 3012-6755-001 PC42E-T Peel Off + LTS Kit

## Cutter

A cutter can be added to any configuration of PC42E-T, simply cutting between labels, or at intervals on continuous media. This method of printing is available on any PC42E-T configuration. 3012-6756-001 PC42E-T Cutter

ID = Inside Diameter  
OD = Outside Diameter

# PC42E-T MEDIA

## Specifications



### Media Hanger + Label Roll Core 38 mm (1.5 in) ID

Shown with Label Roll 127 mm (5 in) OD  
Typical length of material with typical thickness of labels ~ 72 m

### 0.5 in / 1.0 in Ribbon Core Switch

ID = Inside Diameter  
OD = Outside Diameter

# PC42E-T MEDIA

## Specifications

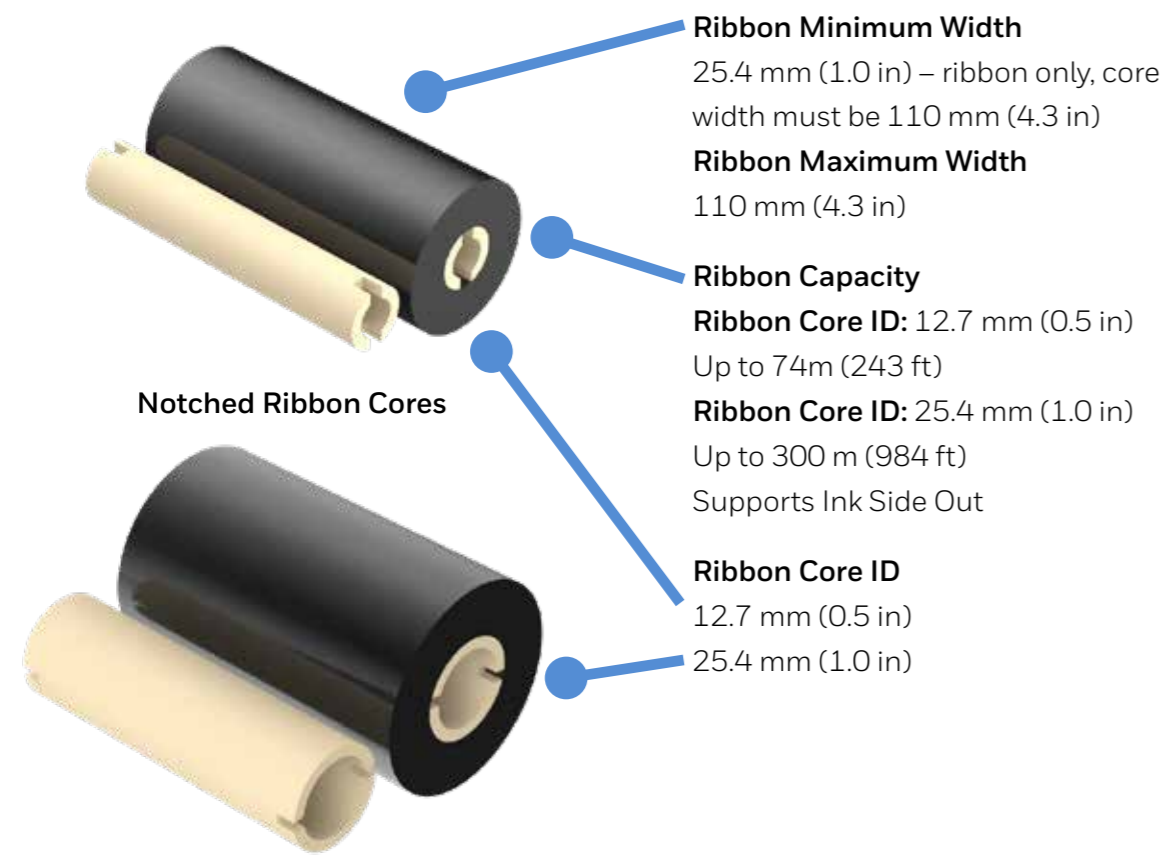

Notched Ribbon Cores

**Ribbon Minimum Width**  
25.4 mm (1.0 in) – ribbon only, core width must be 110 mm (4.3 in)

**Ribbon Maximum Width**  
110 mm (4.3 in)

**Ribbon Capacity**

**Ribbon Core ID:** 12.7 mm (0.5 in)  
Up to 74m (243 ft)

**Ribbon Core ID:** 25.4 mm (1.0 in)  
Up to 300 m (984 ft)  
Supports Ink Side Out

**Ribbon Core ID**

12.7 mm (0.5 in)

25.4 mm (1.0 in)

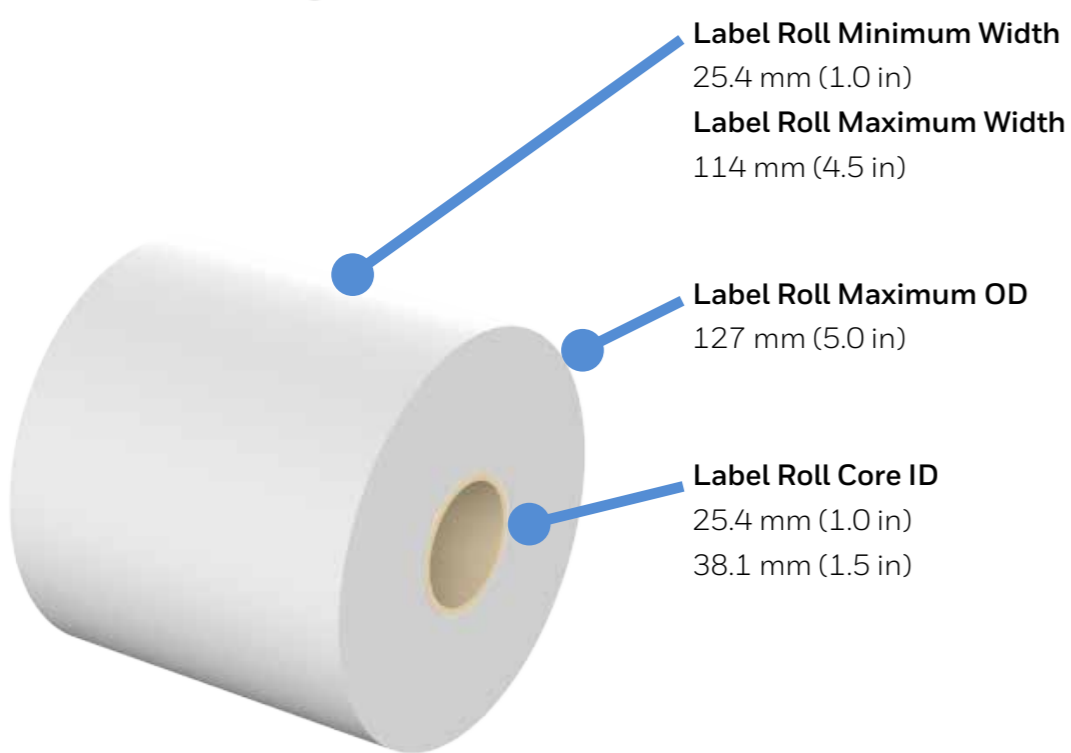

**Label Roll Minimum Width**  
25.4 mm (1.0 in)

**Label Roll Maximum Width**  
114 mm (4.5 in)

**Label Roll Maximum OD**  
127 mm (5.0 in)

**Label Roll Core ID**

25.4 mm (1.0 in)

38.1 mm (1.5 in)

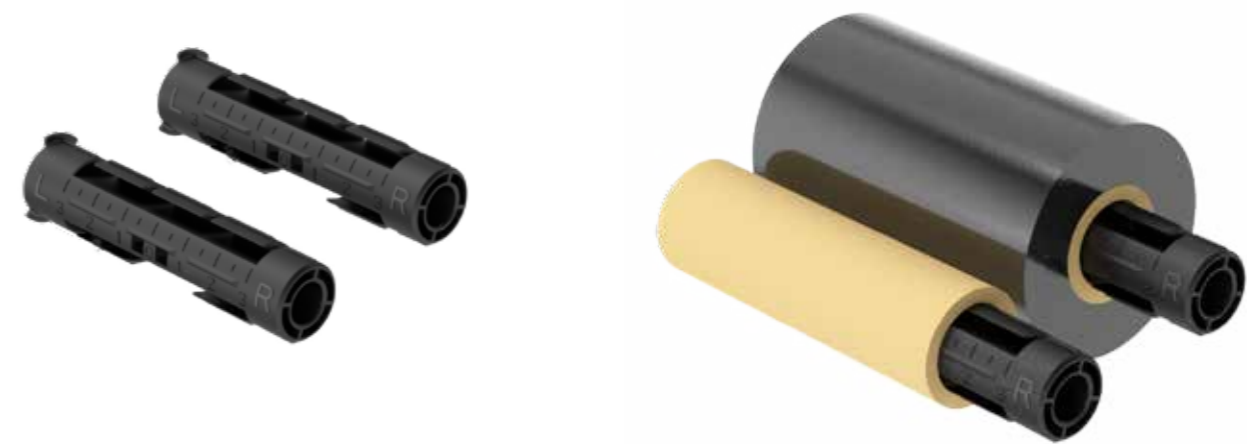

Ribbon Adapter for Notchless Ribbon Cores

3011-9514-001 25.4 mm (1.0 in) Ribbon Core Adapter (1 piece)



0.5 in / 1.0 in Ribbon Core Switch

**Minimum Label Length**

Tear Off 9.6 mm (0.37 in)

Peel-Off Kit 12.5 mm (0.49 in)

Cutter (Full Cut) 25.4 mm (1.0 in)

**Maximum Print Width**

108 mm (4.25 in)



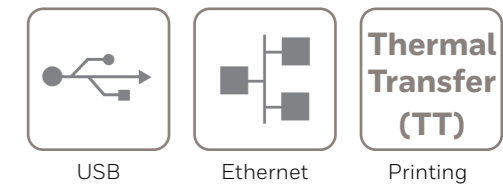

# PC42E-T FEATURE OVERVIEW

**Tear Off - 1-Button/ LED - Black - Thermal Transfer**



### PC42E-T - 1-Button/ LED - Thermal Transfer - 203 dpi

**PC42E-TB02200**

PC42E-T, 4-inch, 1-Button/LED, 128MB RAM/ 128MB Flash, Black, Ethernet + USB + Serial, 1-inch & 0.5-inch Core, Thermal Transfer (TT) 203 dpi, No Power Cord

### PC42E-T - 1-Button/ LED - Thermal Transfer - 300 dpi

**PC42E-TB02300**

PC42E-T, 4-inch, 1-Button/LED, 128MB RAM/ 128MB Flash, Black, Ethernet + USB + Serial, 1-inch & 0.5-inch Core, Thermal Transfer (TT) 300 dpi, No Power Cord

Included in the box:

- PC42E-T
- PC42E-T Regulatory Sheet (PC42E-ML-RS-01)
- Power Supply (203-186-002)
- 1.0 in Ribbon Adapter Core (2 x 3011-9514-001)
- 1.0 in Ribbon Take Up Core



- No Power Cord

- USB Cable (321-576-004)



### Honeywell Repair Services

SVCPC42ET-SG3N

PC42E-T, Edge Service, Gold Maintenance Contract, 3 Year, New Contract

**ADD** SVCPRINTHEAD-PC3

AddOn, Edge Service, Printhead Refresh Service, 203 or 300 dpi, 3-Year Contract

**ADD** SVCACC-PRN3

AddOn, Edge Service, Accessory Service, Printer, 3 Year

Note: Not all printer combinations are available in every region. Check your local Price Book to see which part numbers are available for sale.

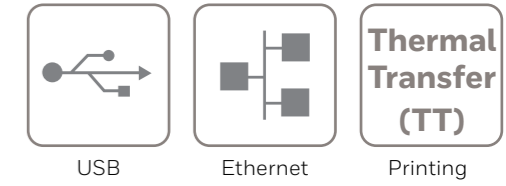

# PC42E-T FEATURE OVERVIEW

**Tear Off - 1-Button/ LED - White - Thermal Transfer**



### PC42E-T - 1-Button/ LED - Thermal Transfer - 203 dpi

**PC42E-TW02200**

PC42E-T, 4-inch, 1-Button/LED, White, Ethernet + USB + Serial, 1-inch & 0.5-inch Core, Thermal Transfer (TT) 203 dpi, No Power Cord

### PC42E-T - 1-Button/ LED - Thermal Transfer - 300 dpi

**PC42E-TW02300**

PC42E-T, 4-inch, 1-Button/LED, White, Ethernet + USB + Serial, 1-inch & 0.5-inch Core, Thermal Transfer (TT) 300 dpi, No Power Cord

Included in the box:

- PC42E-T
- PC42E-T Regulatory Sheet (PC42E-ML-RS-01)
- Power Supply (203-186-002)

- 1.0 in Ribbon Adapter Core (2 x 3011-9514-001)

1.0 in Ribbon Take Up Core



- No Power Cord

- USB Cable (321-576-004)



Note: Not all printer combinations are available in every region. Check your local Price Book to see which part numbers are available for sale.

### Honeywell Repair Services

SVCPC42ET-SG3N

PC42E-T, Edge Service, Gold Maintenance Contract, 3 Year, New Contract

**ADD** SVCPRINTHEAD-PC3

AddOn, Edge Service, Printhead Refresh Service, 203 or 300 dpi, 3-Year Contract

**ADD** SVCACC-PRN3

AddOn, Edge Service, Accessory Service, Printer, 3 Year

# PC42E-T CONFIGURATION MAP

## Desktop Printer

VERSION	HOUSING	CUSTOMIZATION	CONNECTIVITY	PRINT OPTION	POWER CORD	DESCRIPTION	NOTES
<b>PC42E-</b>							
<b>T</b>						Thermal Transfer (TT)	
	<b>B</b>					Black	
	<b>W</b>					White	
		<b>0</b>				Default	
		<b>1</b>				0.5-in ribbon core pre-set	
			<b>2</b>			USB + Ethernet	1 x USB A Port (USB 2.0 Host), 1 x USB B Port (USB 2.0 Device), 1 x Ethernet
				<b>20</b>		203 dpi	Available as Kit - Part# 3012-6757-001 TPH 203DPI,PC42E-T SERIES
				<b>30</b>		300 dpi	Available as Kit - Part# 3012-6758-001 TPH 300DPI,PC42E-T SERIES
					<b>0</b>	None	AC Power Cord C13 Type Connector
					<b>2</b>	US Power Cord	AC Power Cord C13 Type Connector
					<b>4</b>	Hong Kong Power Cord	AC Power Cord C13 Type Connector
					<b>5</b>	India Power Cord	AC Power Cord C13 Type Connector



# HONEYWELL EDGE SERVICES

## PC41E-D / PC42E-D / PC42E-T - Repair Services

Honeywell Edge Services give you the confidence of having leading-class technologies combined with service and support plans that are designed to keep you operational for longer.

For a full description of maintenance services, including terms and conditions, please see <https://sps.honeywell.com/us/en/services/productivity/support-services/maintenance-services>

### Gold Repair Services - 3 Year

The Edge Services Gold Support contract allows flexibility for you to select the right coverage for your organization, including 5-Day Depot Repairs and:

#### Service Overview

- Repair or replacement (at Honeywell discretion) for damaged components, wear and tear, accidental damage
- Flexibility to add any Add-On Service

PART NUMBER	DESCRIPTION
SVCPC41ED-SG3N	PC41E-D, Edge Service, GOLD Maintenance Contract, 5 Day Turnaround, <b>3 Year</b> , New Contract
SVCPC42ED-SG3N	PC42E-D, Edge Service, GOLD Maintenance Contract, 5 Day Turnaround, <b>3 Year</b> , New Contract
SVCPC42ET-SG3N	PC42E-T, Edge Service, GOLD Maintenance Contract, 5 Day Turnaround, <b>3 Year</b> , New Contract

#### Add-On Accessory Replacement Service

Provides replacement cables, interface cards or platen rollers should they be damaged or stop working.

<b>ADD</b> SVCACC-PRN3	AddOn, Edge Service, Accessory Service , Printer, <b>3 Year</b>
------------------------	---

#### Add-On Printhead Refresh Service

Provides replacement 203 or 300 DPI printheads post purchase.

<b>ADD</b> SVCPRINTHEAD-PC3	AddOn, Edge Service, Printhead Refresh Service, 203 or 300 dpi, <b>3 Year</b> , 2 replacement printheads
-----------------------------	--

#### Add-On Device Replacement Service

Replacement devices should a device be damaged beyond repair.

<b>ADD</b> SVCREPLACE-PRN3	AddOn, Edge Service, Device Replacement, Printer, <b>3 Year</b>
----------------------------	---

#### Add-On Cutter Replacement Service

Provides replacement cutters should they be damaged or stop working.

<b>ADD</b> SVCCUTTER1-PRN3	AddOn, Edge Service, Cutter Service for Printers, <b>3 Year</b>
----------------------------	---

#### Add-On Spare Management Service

Manages your spare pool.

<b>ADD</b> SVCSPAREMGMT-PRN3	AddOn, Edge Service, Advanced Exchange, Printer, <b>3 Year</b> . Customer owned spare pool, Minimum Purchase required, contact your local Honeywell Service Representative for more information.
------------------------------	--

#### Add-On 2-Day Turnaround Depot Upgrade

Upgrade your Gold Maintenance Contract from 5-Day to 2-Day turnaround at the repair depot.

<b>ADD</b> SVC2DAYDEPOT-PRN3	AddOn, Edge Service, 2-Day Depot Upgrade, 3-Year Agreement, Requires purchase of a <b>3 Year</b> Gold Maintenance Contract.
------------------------------	---

### Platinum Repair Services - 3 Year

The Edge Services Platinum Support contract offers 2-Day Depot Repairs or Spare Pool Management with 3 year contract that includes:

#### Service Overview

- Repair or replacement (at Honeywell discretion) for damaged components, wear and tear, accidental damage
- SVCREPLACE-PRN3 - Replacement devices should a device be damaged beyond repair
- SVCACC-PRN3 - Accessory replacement service
- SVCPRINTHEAD-PC3 - Provides 2 x replacement 203 or 300 dpi printheads.
- SVCSPAREMGMT-PRN3 - Spare pool management (optional, minimum quantity required)
- SVCCUTTER1-PRN3 - Provides replacement cutters should they be damaged or stop working.
- Telephone-based technical support

PART NUMBER	DESCRIPTION
SVCPC41ED-SP3N	PC41E-D, Edge Service, PLATINUM, 2 Day Turnaround, <b>3 Year</b> , New Contract
SVCPC42ED-SP3N	PC42E-D, Edge Service, PLATINUM, 2 Day Turnaround, <b>3 Year</b> , New Contract
SVCPC42ET-SP3N	PC42E-T, Edge Service, PLATINUM, 2 Day Turnaround, <b>3 Year</b> , New Contract



# HONEYWELL EDGE SERVICES

## PC41E-D / PC42E-D / PC42E-T - Repair Services

Honeywell Edge Services give you the confidence of having leading-class technologies combined with service and support plans that are designed to keep you operational for longer.

For a full description of maintenance services, including terms and conditions, please see <https://sps.honeywell.com/us/en/services/productivity/support-services/maintenance-services>

### Gold Repair Services - 5 Year

The Edge Services Gold Support contract allows flexibility for you to select the right coverage for your organization, including 5-Day Depot Repairs and:

#### Service Overview

- Repair or replacement (at Honeywell discretion) for damaged components, wear and tear, accidental damage
- Flexibility to add any Add-On Service

PART NUMBER	DESCRIPTION
SVCPC41ED-SG5N	PC41E-D, Edge Service, GOLD Maintenance Contract, 5 Day Turnaround, <b>5 Year</b> , New Contract
SVCPC42ED-SG5N	PC42E-D, Edge Service, GOLD Maintenance Contract, 5 Day Turnaround, <b>5 Year</b> , New Contract
SVCPC42ET-SG5N	PC42E-T, Edge Service, GOLD Maintenance Contract, 5 Day Turnaround, <b>5 Year</b> , New Contract

#### Add-On Accessory Replacement Service

Provides replacement cables, interface cards or platen rollers should they be damaged or stop working.

<b>ADD</b> SVCACC-PRN5	AddOn, Edge Service, Accessory Service , Printer, <b>5 Year</b>
------------------------	---

#### Add-On Printhead Refresh Service

Provides replacement 203 or 300 DPI printheads post purchase.

<b>ADD</b> SVCPRINHEAD-PC5	AddOn, Edge Service, Printhead Refresh Service, 203 or 300 dpi, <b>5 Year</b> , 3 replacement printheads
----------------------------	--

#### Add-On Device Replacement Service

Replacement devices should a device be damaged beyond repair.

<b>ADD</b> SVCREPLACE-PRN5	AddOn, Edge Service, Device Replacement, Printer, <b>5 Year</b>
----------------------------	---

#### Add-On Cutter Replacement Service

Provides replacement cutters should they be damaged or stop working.

<b>ADD</b> SVCCUTTER1-PRN5	AddOn, Edge Service, Cutter Service for Printers, <b>5 Year</b>
----------------------------	---

#### Add-On Spare Management Service

Manages your spare pool.

<b>ADD</b> SVCSPAREMGMT-PRN5	AddOn, Edge Service, Advanced Exchange, Printer, <b>5 Year</b> . Customer owned spare pool, Minimum Purchase required, contact your local Honeywell Service Representative for more information.
------------------------------	--

#### Add-On 2-Day Turnaround Depot Upgrade

Upgrade your Gold Maintenance Contract from 5-Day to 2-Day turnaround at the repair depot.

<b>ADD</b> SVC2DAYDEPOT-PRN5	AddOn, Edge Service, 2-Day Depot Upgrade, 5-Year Agreement, Requires purchase of a <b>5 Year</b> Gold Maintenance Contract.
------------------------------	---

### Platinum Repair Services - 5 Year

The Edge Services Platinum Support contract offers 2-Day Depot Repairs or Spare Pool Management with 5 year contract that includes:

#### Service Overview

- Repair or replacement (at Honeywell discretion) for damaged components, wear and tear, accidental damage
- SVCREPLACE-PRN5 - Replacement devices should a device be damaged beyond repair
- SVCACC-PRN5 - Accessory replacement service
- SVCPRINHEAD-PC5 - Provides 3 x replacement 203 or 300 dpi printheads.
- SVCSPAREMGMT-PRN5 - Spare pool management (optional, minimum quantity required)
- SVCCUTTER1-PRN5 - Provides replacement cutters should they be damaged or stop working.
- Telephone-based technical support

PART NUMBER	DESCRIPTION
SVCPC41ED-SP5N	PC41E-D, Edge Service, PLATINUM, 2 Day Turnaround, <b>5 Year</b> , New Contract
SVCPC42ED-SP5N	PC42E-D, Edge Service, PLATINUM, 2 Day Turnaround, <b>5 Year</b> , New Contract
SVCPC42ET-SP5N	PC42E-T, Edge Service, PLATINUM, 2 Day Turnaround, <b>5 Year</b> , New Contract



# HONEYWELL REPAIR SERVICES

## PC41E-D / PC42E-D / PC42E-T - Repair Services Coverage

Service options tailored to customer requirements

**BASIC**



PC41E-D    PC42E-D



PC42E-T

Warranty Cover Against Product Defect

**GOLD**

Gold Coverage:

- Accidental Damage
- Wear & Tear

Flexible GOLD Add-Ons ordered separately

- SVCACC-PRN3    Accessories
- SVCPRINTHEAD-PC3    Printhead Replacement
- SVCREPLACE-PRN3    Device Replacement
- SVCCUTTER1-PRN3    Cutter Replacement
- SVCSPAREMGMT-PRN3    Advanced Exchange

**PLATINUM**

Platinum Coverage

- Printhead Replacement
- Coverage for Cables and Interface Cards
- Cutter Replacement
- Accidental Damage
- Device Replacement
- Wear & Tear



Printhead  
(3 Year – 1 replacement printhead)  
(5 Year – 2 replacement printheads)



Cutter



Power Supply

MODEL	COVERAGE	PART NUMBER	DESCRIPTION
PC41E-D / PC42E-D	BASIC	SVCPC41ED-EXW3 / SVCPC42ED-EXW3	BASIC, 10-15 Day Turnaround, 3 Years (1 Year Factory Warranty + 2 Year Extended)
PC42E-T	BASIC	SVCPC42ET-EXW3	PC42E-T, BASIC, 10-15 Day Turnaround, 3 Years (1 Year Factory Warranty + 2 Year Extended)
PC41E-D / PC42E-D	GOLD	SVCPC41ED-SG3N / SVCPC42ED-SG3N	Edge Service, GOLD Maintenance Contract, 5 Day Turnaround, 3 Year, New Contract
PC42E-T	GOLD	SVCPC42ET-SG3N	PC42E-T, Edge Service, GOLD Maintenance Contract, 5 Day Turnaround, 3 Year, New Contract
	ADD	SVCACC-PRN3	AddOn, Edge Service, Accessory Service, Printer, 3 Year.
	ADD	SVCPRINTHEAD-PC3	AddOn, Edge Service, 203 or 300 dpi Printhead Refresh Service, 3-Year Contract, 2 replacement printheads
	ADD	SVCREPLACE-PRN3	AddOn, Edge Service, Device Replacement, Printer, 3 Year
	ADD	SVCCUTTER1-PRN3	AddOn, Edge Service, Cutter Service for Printer, 3-Year
	ADD	SVCSPAREMGMT-PRN3	AddOn, Edge Service, Advanced Exchange, Printer, 3 Year. Customer owned spare pool, Minimum Purchase required.
PC41E-D / PC42E-D	PLATINUM	SVCPC41ED-SP3N / SVCPC42ED-SP3N	Edge Service, PLATINUM, 2 Day Turnaround, 3 Year, New Contract
PC42E-T	PLATINUM	SVCPC42ET-SP3N	PC42E-T, Edge Service, PLATINUM, 2 Day Turnaround, 3 Year, New Contract

# ACCESSORIES

## PC42E-D / PC42E-T - Wi-Fi and Bluetooth Card

The Wi-Fi and Bluetooth card can be easily added to any PC42E-D or PC42E-T printer.

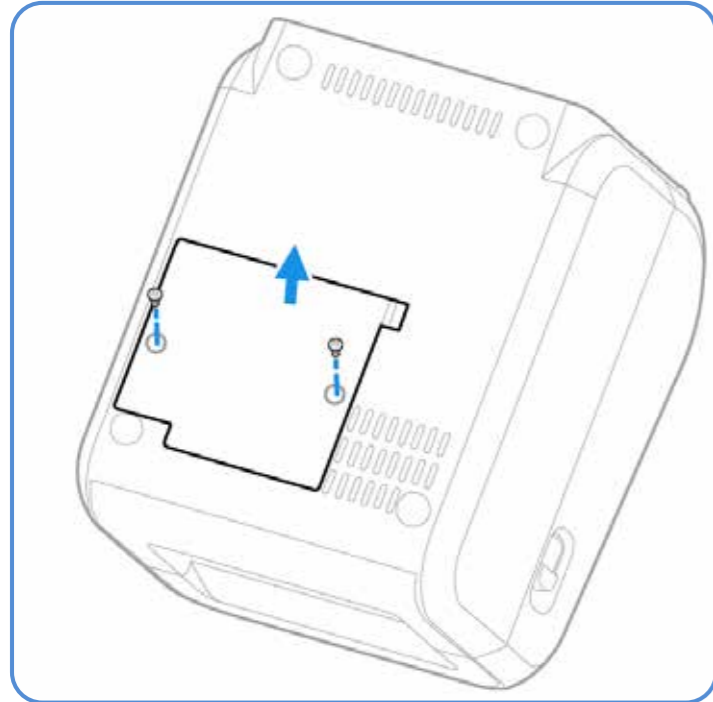

PC42E-D - Wi-Fi/BT Module Door



PART NUMBER	REGION	DESCRIPTION
3012-6759-001	Europe/ APAC/ META/ China	Wi-Fi 5 802.11 a/b/g/n/ac + V5.0 Bluetooth Kit
3012-6760-001	North America	Wi-Fi 5 802.11 a/b/g/n/ac + V5.0 Bluetooth Kit
3012-6761-001	LATAM	Wi-Fi 5 802.11 a/b/g/n/ac + V5.0 Bluetooth Kit
3012-6753-001	Global	Bluetooth/BLE v5.0 Only Kit

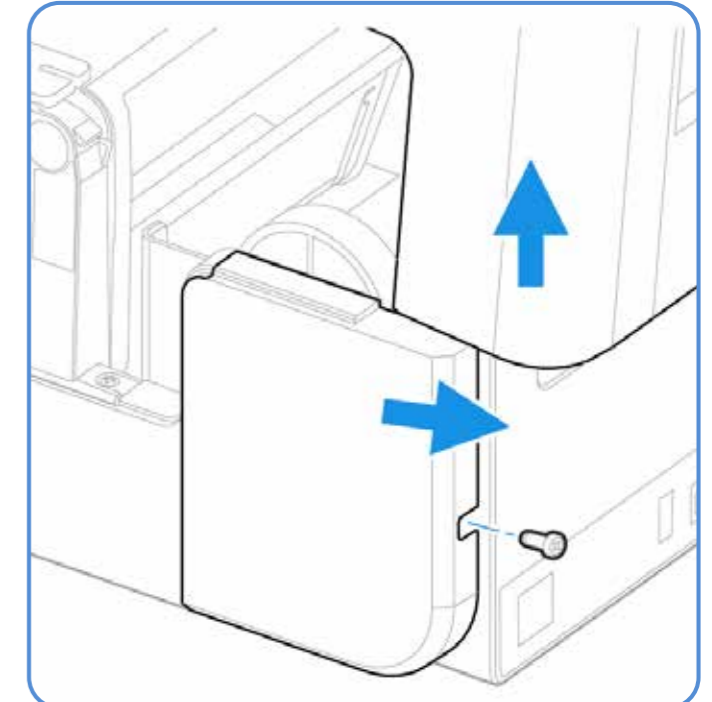

PC42E-T - Wi-Fi/BT Module Door

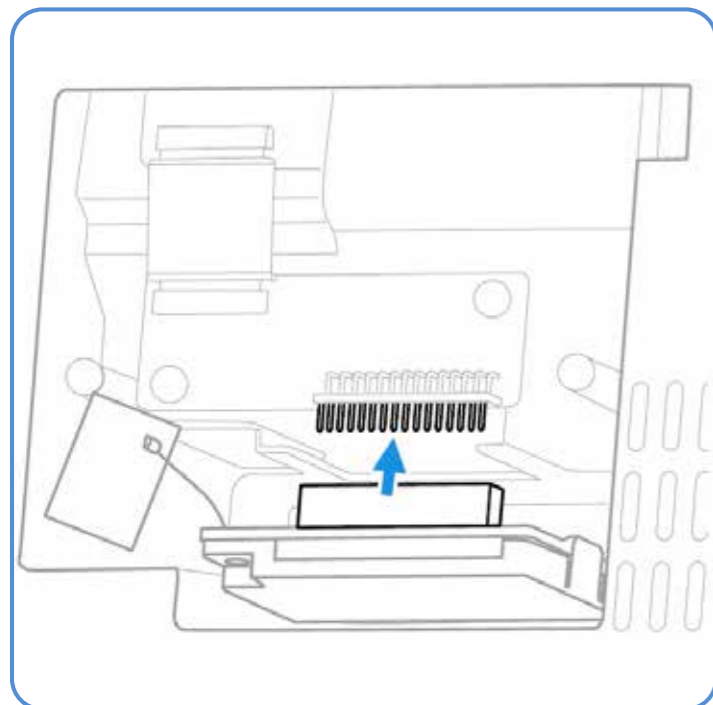

PC42E-D - Insert Wi-Fi/ Bluetooth board

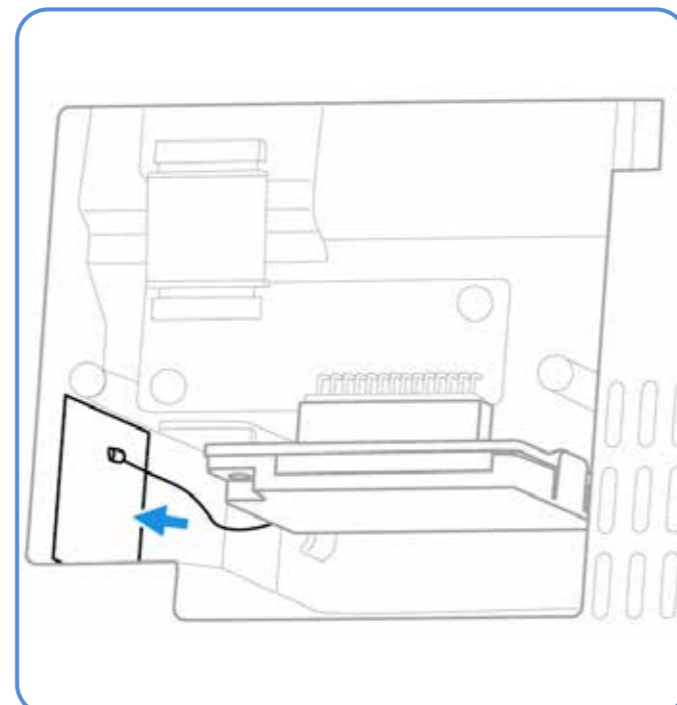

PC42E-D - Adhere antenna

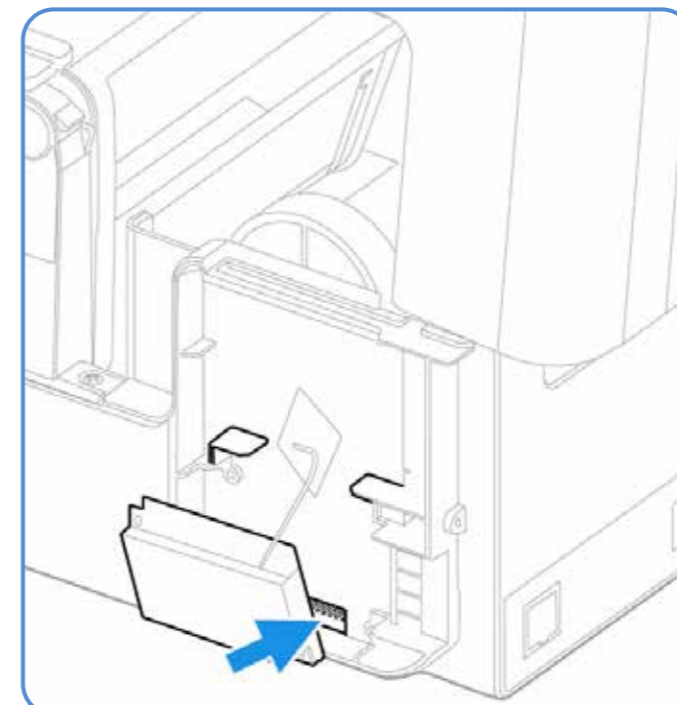

PC42E-T - Insert Wi-Fi/ Bluetooth board

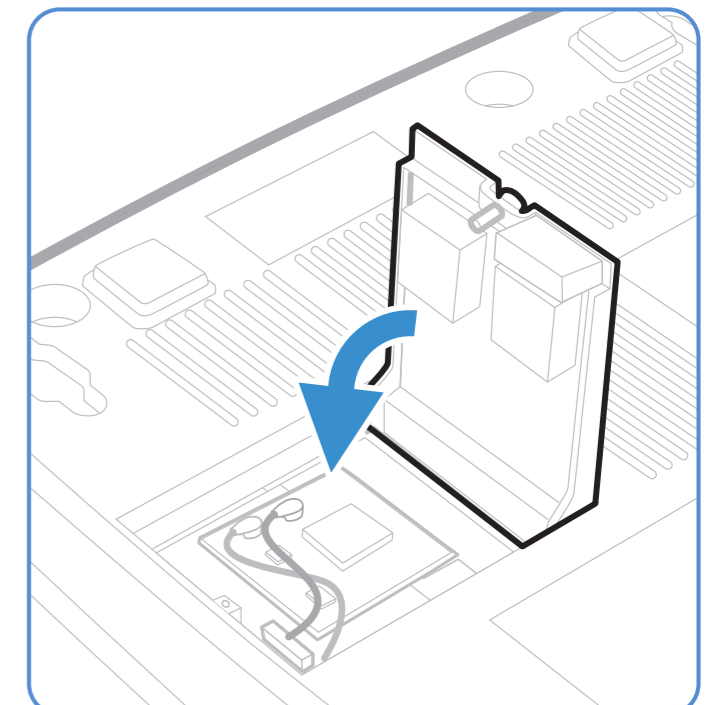

PC42E-T - Adhere antenna

# ACCESSORIES

## PC42E-D Cutter

In cut-off printing, each label is automatically cut from the media roll immediately after the label is printed. You can print on non-adhesive, continuous label stock, and also self-adhesive labels with a liner.



Standard Cutter

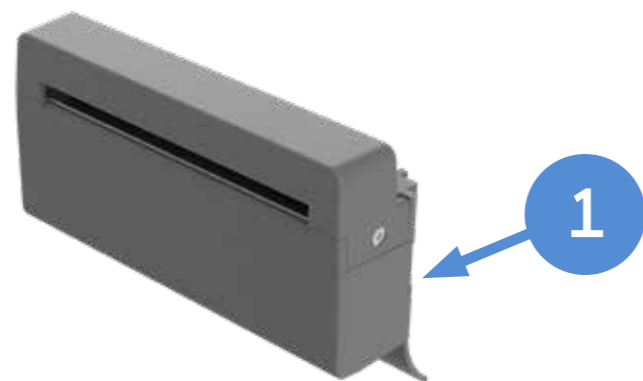

PART NUMBER	MEDIA	DESCRIPTION
1 3012-6756-002	RECEIPT & LABELS	Kit, Cutter, PC42E-T/PC42E-D

## PC42E-T Cutter

In cut-off printing, each label is automatically cut from the media roll immediately after the label is printed. You can print on non-adhesive, continuous label stock, and also self-adhesive labels with a liner.



Standard Cutter

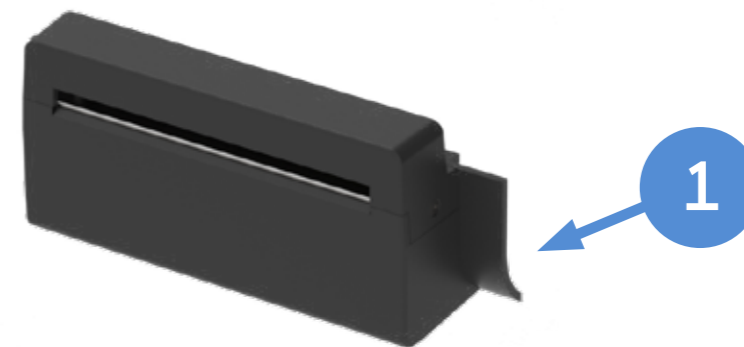

PART NUMBER	MEDIA	DESCRIPTION
1 3012-6756-001	RECEIPT & LABELS	KIT,CUTTER,PC42E-T

# ACCESSORIES

## PC42E-D Peel Off (Self Strip)

To use the self strip accessory for printing, you print labels on self-adhesive label stock with a liner. As each label is printed, the label is automatically peeled from the liner and is presented at the front of the printer for manual removal.



## PC42E-T Peel Off (Self Strip)

To use the self strip accessory for printing, you print labels on self-adhesive label stock with a liner. As each label is printed, the label is automatically peeled from the liner and is presented at the front of the printer for manual removal.



PART NUMBER	MEDIA	DESCRIPTION
1 3012-6755-002	LABELS	Kit, Peel Off, PC42E-T/PC42E-D

PART NUMBER	MEDIA	DESCRIPTION
1 3012-6755-001	LABELS	KIT,PEEL OFF,PC42E-T

# ACCESSORIES

## Consumables and Cables



PART NUMBER	MODEL	DESCRIPTION
3012-6757-001	PC42E-T	TPH 203DPI,PC42E-T SERIES
3012-6758-001	PC42E-T	TPH 300DPI,PC42E-T SERIES
3012-6757-002	PC41E-D/PC42E-D	TPH 203DPI,PC41E-D/PC42E-D SERIES
3012-6758-002	PC41E-D/PC42E-D	TPH 300DPI,PC41E-D/PC42E-D SERIES

PART NUMBER	DESCRIPTION
1-110501-00	Cleaning Card, 4.5"x6", box of 25

PART NUMBER	DESCRIPTION
321-576-004	USB (USB-A to USB-B) cable, 6.5 ft. (2 m) length



PART NUMBER	DESCRIPTION
3012-6754-002	Kit, Roller, PC41E-D/PC42E-D

PART NUMBER	DESCRIPTION
3012-6754-001	Kit, Roller, PC42E-T SERIES

PART NUMBER	DESCRIPTION
3012-6762-001	USB to Serial Cable,PC42E-T SERIES

# MISCELLANEOUS

## Power Supply

Replacement Power Supply.



IEC C14

**PART NUMBER**      **DESCRIPTION**

1      203-186-002      Universal Power Adapter 100V-240V AC input, PC41E-D/PC42E-D/PC42E-T Series Printers

## AC Cords

Regional Power Cords





AC Power - C13 Type Connector

**PART NUMBER**      **TYPE**      **DESCRIPTION**

3013-1460-001	C13	AC Power Cord, 1.5m, Argentina
3013-1457-001	C13	AC Power Cord, 1.5m, Australia/ New Zealand
3013-1452-001	C13	AC Power Cord, 1.5m, Brazil
3013-1454-001	C13	AC Power Cord, 1.5m, Europe (EU)
3013-1456-001	C13	AC Power Cord, 1.5m, India
3013-1458-001	C13	AC Power Cord, 1.5m, Israel
3013-1455-001	C13	AC Power Cord, 1.5m, Korea
3013-1462-001	C13	AC Power Cord, 1.5m, South Africa
3013-1459-001	C13	AC Power Cord, 1.5m, UK
3013-1453-001	C13	AC Power Cord, 1.5m, USA













# APPENDIX

## PC41E-D / PC42E-D / PC42E-T Accessories

ACCESSORIES										
Category	Description	 PC41E-D	 PC42E-D	 PC42E-D	 PC42E-T	 PC42E-T	Is the PC42E-D part the same as PC42E-T?	Is the PC42E-T part compatible with PC42E-D?	Customer Installable	Notes
Platen Roller	Platen Roller Kit	 3012-6754-002	 3012-6754-002	 3012-6754-002	 3012-6754-001	 3012-6754-001	No	No	Yes	PC42E-T Platen Roller is wider than PC42E-D Platen Roller.
Printheads	203 DPI Printhead Assembly, 4"	3012-6757-002	3012-6757-002	3012-6757-002	3012-6757-001	3012-6757-001	No	No	Yes	
	300 DPI Printhead Assembly, 4"	3012-6758-002	3012-6758-002	3012-6758-002	3012-6758-001	3012-6758-001	No	No	Yes	
Ribbon Adapters	1.0 inch Ribbon Adapters	-	-	-	 3011-9514-001	 3011-9514-001	-	-	-	
Wi-Fi / Bluetooth	Kit, Wireless LAN, Europe (EU)	-	3012-6759-001 (a/b/g/n/ac)	3012-6759-001 (a/b/g/n/ac)	3012-6759-001 (a/b/g/n/ac)	3012-6759-001 (a/b/g/n/ac)	Yes	Yes	Yes	
	Kit, Wireless LAN, North America (NA)	-	3012-6760-001 (a/b/g/n/ac)	3012-6760-001 (a/b/g/n/ac)	3012-6760-001 (a/b/g/n/ac)	3012-6760-001 (a/b/g/n/ac)	Yes	Yes	Yes	
	Kit, Wireless LAN, Rest Of World (ROW)	-	3012-6761-001 (a/b/g/n/ac)	3012-6761-001 (a/b/g/n/ac)	3012-6761-001 (a/b/g/n/ac)	3012-6761-001 (a/b/g/n/ac)	Yes	Yes	Yes	
Label Dispenser	Self Strip (Label Dispenser)	-	 3012-6755-002	 3012-6755-002	 3012-6755-001	 3012-6755-001	No	No	Yes	
Cutter	Cutter Kit	-	 3012-6756-002	 3012-6756-002	 3012-6756-001	 3012-6756-001	No	No	Yes	

# APPENDIX

## Connectivity - Compare PC41E-D / PC42E-D / PC42E-T

CONNECTIVITY					
	 <b>PC41E-D</b>	 <b>PC42E-D</b>	 <b>PC42E-D</b>	 <b>PC42E-T</b>	 <b>PC42E-T</b>
<b>Communications</b>					
USB Host	Standard (1x USB-A Rear)	Standard (1x USB-A Rear)	Standard (1x USB-A Rear)	Standard (1x USB-A Rear)	Standard (1x USB-A Rear)
USB Client	Standard (1x USB-B Rear)	Standard (1x USB-B Rear)	Standard (1x USB-B Rear)	Standard (1x USB-B Rear)	Standard (1x USB-B Rear)
Serial	Optional  3012-6762-001 USB to Serial Cable	Standard	Standard	Optional  3012-6762-001 USB to Serial Cable	Optional  3012-6762-001 USB to Serial Cable
Parallel	Not supported	Not supported	Not supported	Not supported	Not supported
Ethernet	Not supported	Standard	Standard	Standard	Standard
Wi-Fi / Bluetooth	Not supported	Optional  3012-6759-001 Wi-Fi/BT Module 3012-6760-001 Wi-Fi/BT Module 3012-6761-001 Wi-Fi/BT Module 3012-6753-001 BT Only Module	Optional  3012-6759-001 Wi-Fi/BT Module 3012-6760-001 Wi-Fi/BT Module 3012-6761-001 Wi-Fi/BT Module 3012-6753-001 BT Only Module	Optional  3012-6759-001 Wi-Fi/BT Module 3012-6760-001 Wi-Fi/BT Module 3012-6761-001 Wi-Fi/BT Module 3012-6753-001 BT Only Module	Optional  3012-6759-001 Wi-Fi/BT Module 3012-6760-001 Wi-Fi/BT Module 3012-6761-001 Wi-Fi/BT Module 3012-6753-001 BT Only Module
Apple iOS MFi Certification	Not supported	Not supported	Not supported	Not supported	Not supported

# MISCELLANEOUS

## Disclaimer

---

### Disclaimer

Honeywell International Inc. (“HII”) reserves the right to make changes in specification and other information contained in this document without prior notice, and the reader should in all cases consult HII to determine whether any such changes have been made. The information in this publication does not represent a commitment on the part of HII.

HII shall not be liable for technical or editorial errors or omissions contained herein; nor for incidental or consequential damages resulting the furnishing, performance, or use of this material.

This document contains proprietary information that is protected by copyright. All rights are reserved. No part of this document may be photocopied, reproduced, or translated into another language with-out prior written consent of HII.

Web Address: [automation.honeywell.com](http://automation.honeywell.com)

The Bluetooth trademarks are owned by Bluetooth SIG, Inc., U.S.A and licensed to Honeywell.

Apple, iOS, iPod touch and iPhone are trademarks of Apple Inc., registered in the U.S. and other countries. App Store is a service mark of Apple Inc.

Android is a trademark or registered trademark of Google Inc. in the United States and/or other countries. Windows is a trademark or registered trademark of Microsoft Corporation.

Other product names mentioned in the manual may be trademarks of registered trademarks of their respective companies and are the property of their respective owners.

All rights reserved.

### For more information

[automation.honeywell.com](http://automation.honeywell.com)

### Honeywell Safety and Productivity Solutions

855 S Mint St  
Charlotte, NC 28202  
800-582-4263  
[www.honeywell.com](http://www.honeywell.com)